

## 1. Before Installation

1.1 Please check the parts before installation.

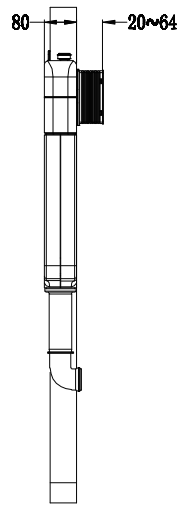

**VERY IMPORTANT:**  
ONCE YOU HAVE INSTALLED THE CISTERN IT IS VERY IMPORTANT THAT YOU TEST IT BEFORE TILING YOUR WALLS.

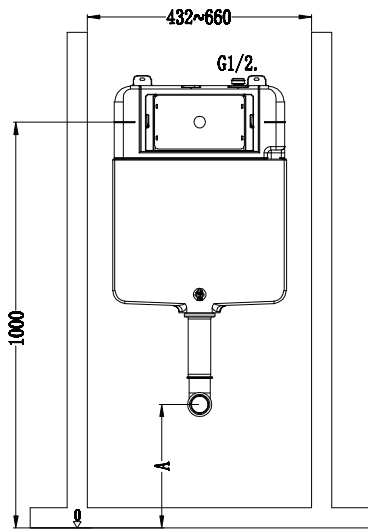
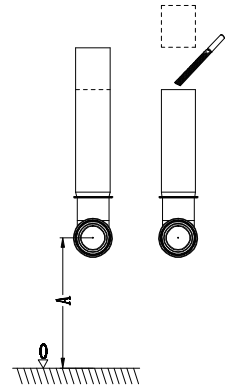
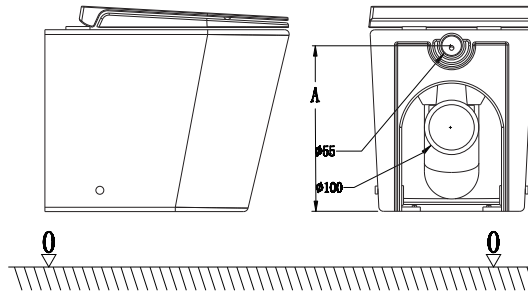

1.2 Tools and Materials required: Measuring tape, pencil, hammer, sealant, Hammer drill, Phillips screwdriver, level, cutter and hand file.

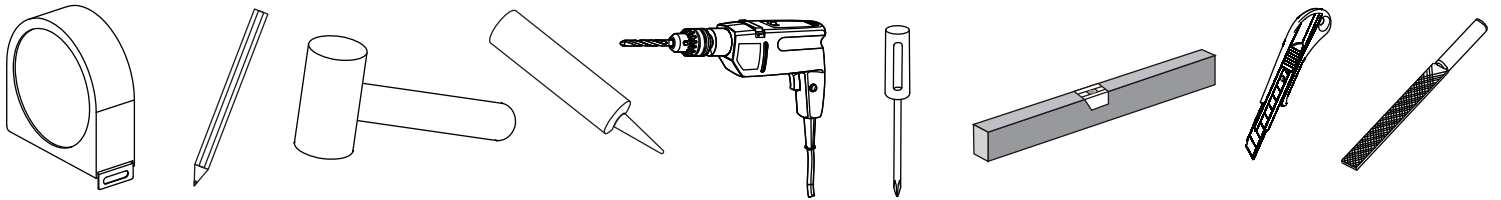

## 2. Installation Procedure

2.1 Connection of the water inlet pipe.

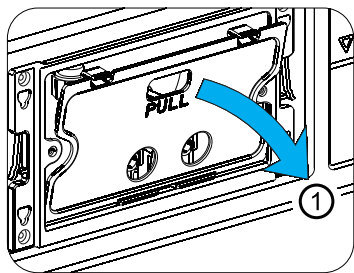

2.1.1 Remove the panel board.

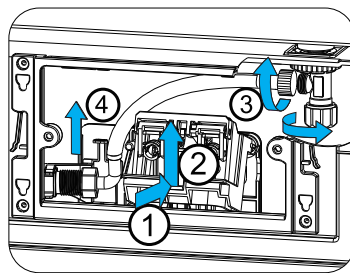

2.1.2 Remove the bolts and flush valve.

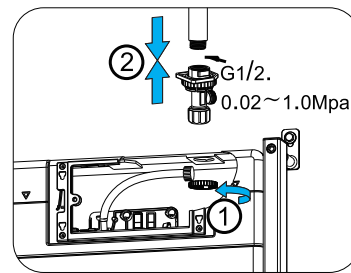

2.1.3 Connect the water inlet pipe.

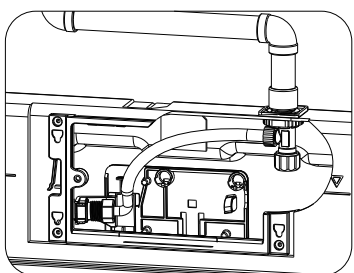

2.1.4 Tighten the hose.

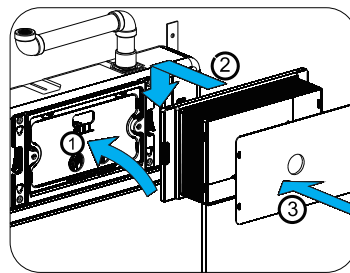

2.1.5 Tighten the flush valve and bolt frame, then install the panel frame and panel board.

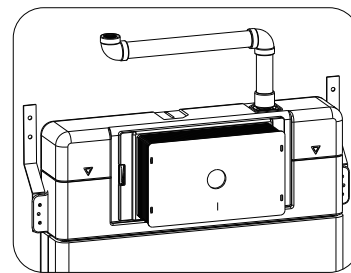

2.1.6 Finished.

## 2.2 Install the concealed cistern.

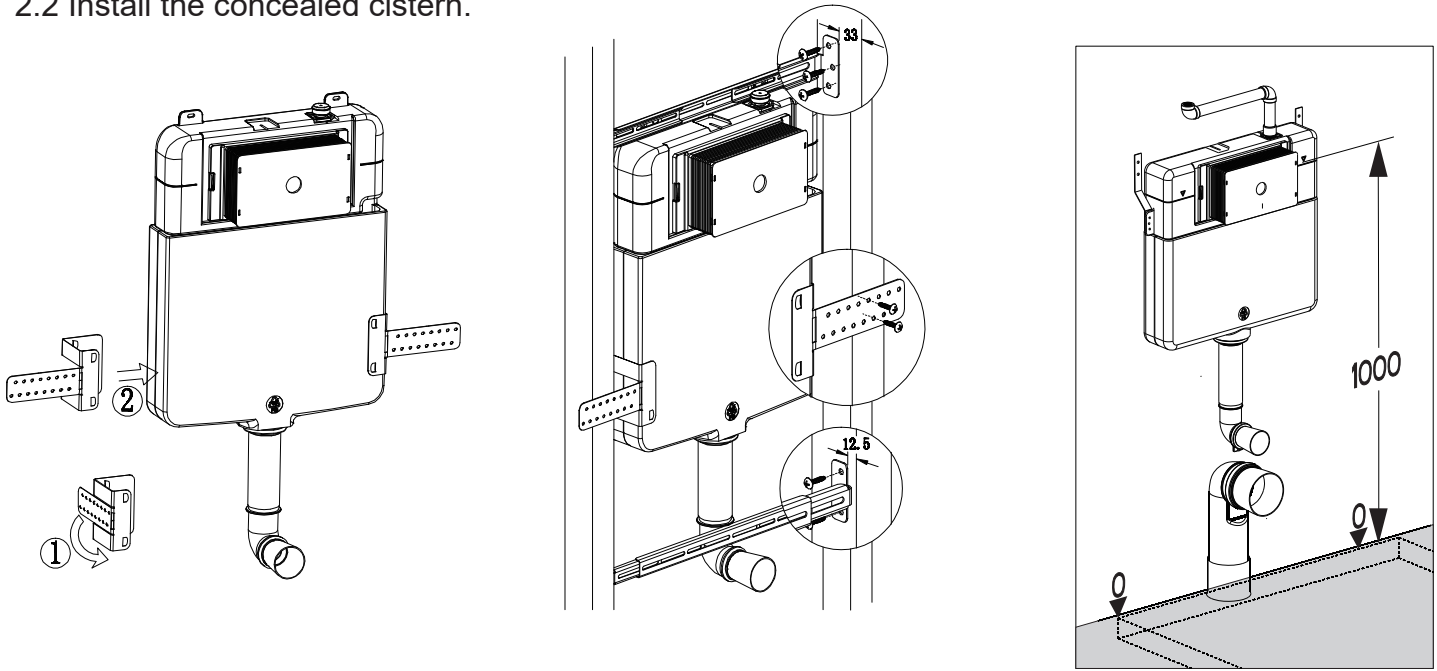

2.2.1 Tighten the screws.

2.2.2 Install the waste pipe.

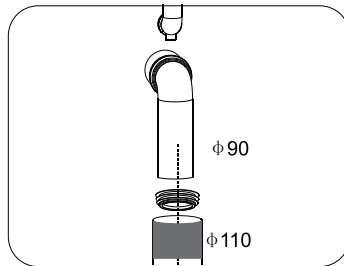

2.2.3 Use the pipe gasket to connect the waste pipe of  $\phi 90$ mm and  $\phi 110$ mm.

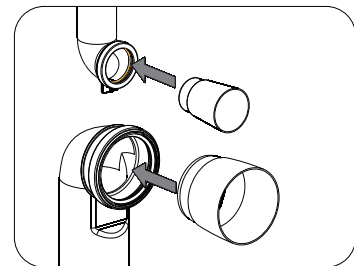

2.2.4 Put the pollution and flush cup on the pollution and flush pipe.

## 2.3 Install the flush panel

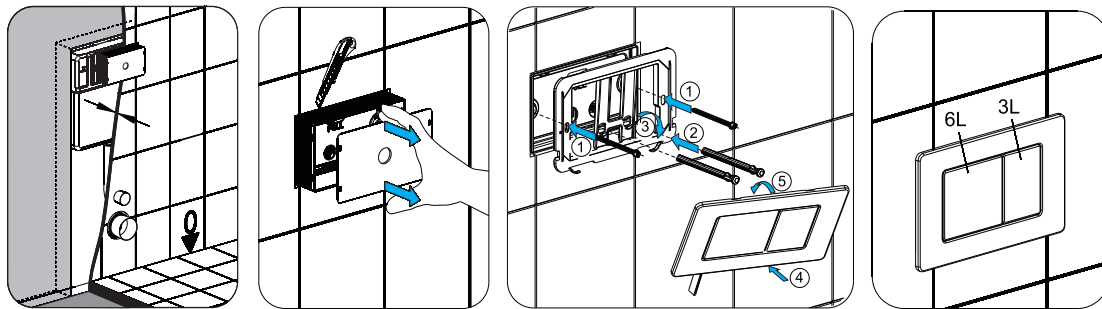

2.3.1 Cut the cistern frame close to the tiles/ wall.

2.3.2 Screw the flush rods and connective rods. Install the flush panel.

2.3.3 Finalise the installation of flush panel.

## 2.4 Install the toilet

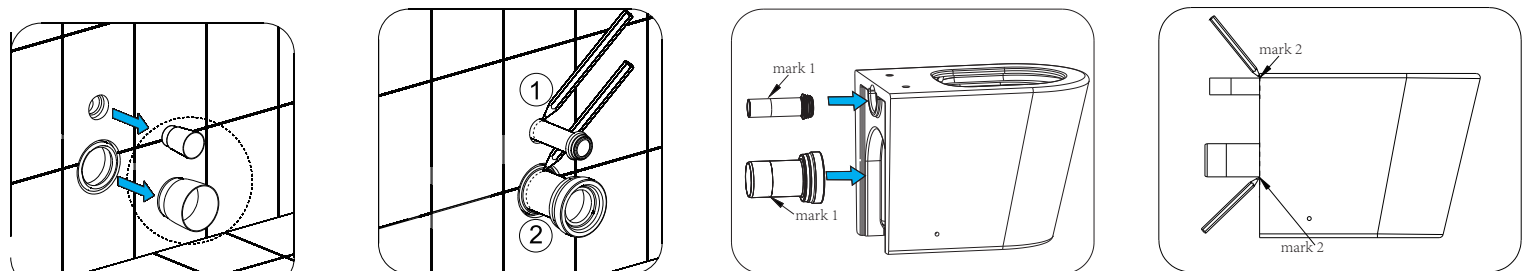

2.4.1 Dispose the pollution and flush cup.

2.4.2&3 Insert the straight pipes into the cistern and mark them as per the diagram.

2.4.4 Insert the straight pipes into the toilet and mark them as per the diagram.



2.4.5 Shorten part of L2+3mm.



2.4.6 Shorten part of L3+3mm.



Please make sure you have cut the flush pipe to the correct length. Failure to do so, will result in leakage.

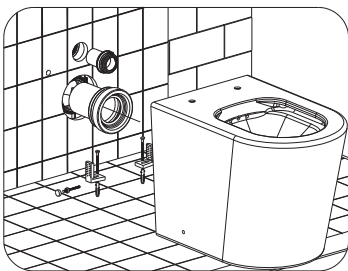

2.4.7 Measure the distance for the anchor screws and fix them on the floor. Apply the sealant to both pipes, then insert them into the cistern and install the toilet.

## 2.5 Install the toilet seat and cover

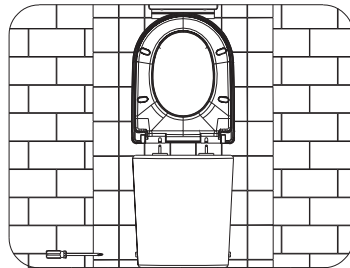
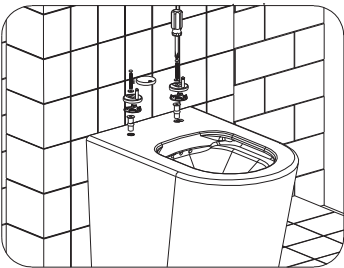

2.5.1 Fix and screw the expansion sleeve, base, bolts, and decorative cover in sequence.

2.5.2 Install the toilet seat and cover.

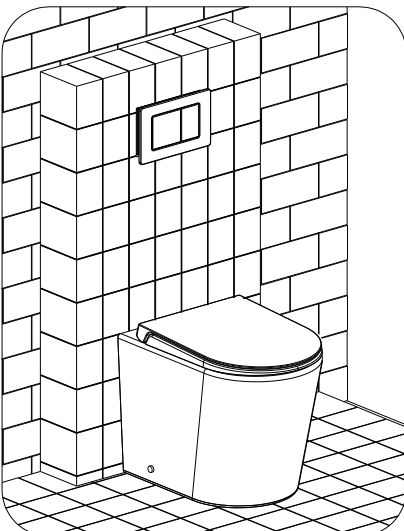

2.5.3 Finished.



## 3. Maintenance

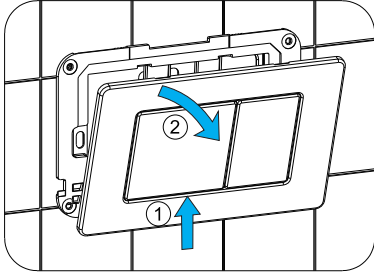

3.1 Remove the flush panel.

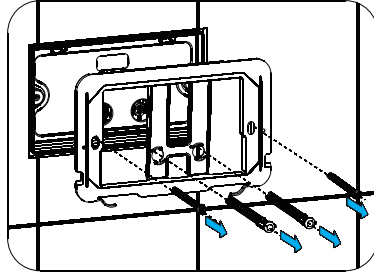

3.2 Remove the flush rods and connective rods.

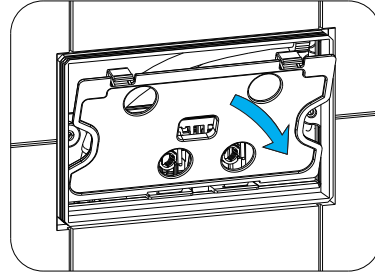

3.3 Remove the panel board.

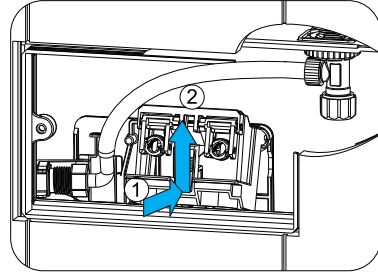

3.4 Remove the bolt frame combination.

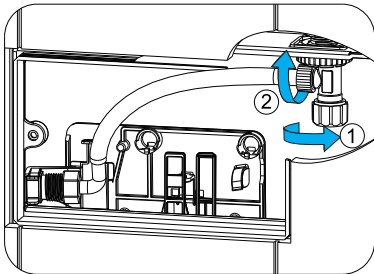

3.5 Unscrew the water inlet pipe.

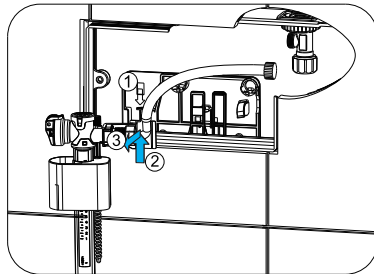

3.6 Remove the water inlet valve.

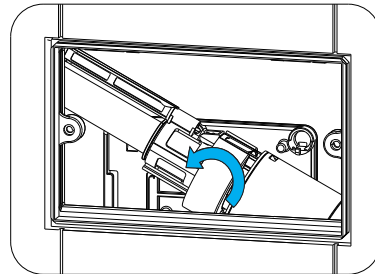

3.7&3.8 Remove the flush valve and bracket of the flush valve.

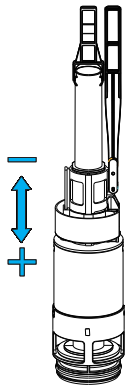
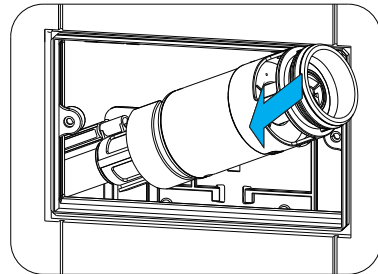

3.9 Adjust the small flush water volume.

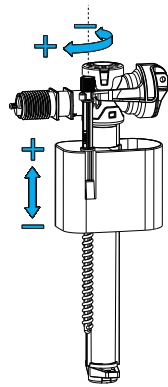

3.10 Turn over the knob, adjust the water level height.

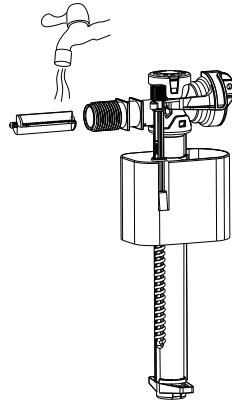

3.11 Clean the water inlet valve.

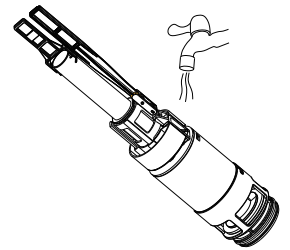

3.12 Clean the flush valve.